

iT0620 Ice Cube Machine

Models

- IRT0620A
 IDT0620A
 IYT0620A
 IDT0620W
 IYT0620W



Indigo NXT Series iT0620 Ice Machine on D420 Bin

*Ice machine and Bin sold separately

Designed for operators who know that ice is critical to their business, the Indigo[®]w Series ice machine's preventative diagnostics continually monitor itself for reliable ice production. Improvements in cleanability and programmability make your ice machine easy to own and less expensive to operate.

- **Space-Saving Design** – Measures only 16.5" high (42 cm) and 30" wide (76.20 cm) allowing it to fit on top of dispensers when a low ceiling is an issue.
- **easyTouch[®] Display**- New icon based touch screen takes the guess work out of owning and operating an ice machine.
- **Programmable Ice Production** – Now its super easy to program your ice machine to be off at certain times of the day to save money with fluctuating electrical rates. Also programmable by daily ice production volume and night time programming.
- **Easy to Clean Foodzone** – Hinged front door swings out for easy access. Removable water-trough, distribution tube, curtain, and sensing probes for fast and efficient cleaning. Select components made with AlphaSan[®] antimicrobial.
- **Intelligent Diagnostics** – Provide 24 hour preventative maintenance and diagnostic feedback for trouble free operation.
- **Acoustical Ice Sensing Probe** – Unique patented technology allows for reliable operation in challenging water conditions and environments.
- **DuraTech[™] Exterior** – Provides superior corrosion resistant above stainless steel. Innovative clear-coat resists fingerprints and dirt making it easier to keep clean.
- **Available LuminIce II Virus and Bacteria Inhibitor**- Controls viruses, bacteria, mold and yeast within the food zone to keep the ice machine clean longer. A new sanitation icon lets you know the operational status.
- **Active sense** - Insures consistent ice harvest in all environmental conditions. This software solution works in conjunction with the acoustical ice sensing probe improving reliability and performance.

Ice Machine Electric

115/60/1 standard
(208-230/60/1 also available)

Minimum circuit ampacity:

Air-cooled: 12.2, 115v 5.9, 208-230V
Water-cooled: 11.6,-115v, 5.6,-208-230v

Maximum fuse size:

Air-cooled: 20A for 115v, 15A for 208-230v
Water-cooled: 20A, 115v and 15A, 208-230v



Specifications

BTU Per Hour:
5,400 (average),
and 6,300 (peak)

Refrigerant:

R410A CFS - Free
Lowers global warming
by 48%

Operating Limits:

- Ambient Temperature Range:
40 to 110 F (4.4 to 43.3 C)
Water Temperature Range:
40 to 90 F (4.4 to 32.2 C)
- Potable Water Pressure:
Min. 20 psi (137.9 kPa)
Max. 80 psi (551.1 kPa)
- Condenser Water Pressure:
Min. 20 psi (137.9 kPa)
Max. 276 psi (551.1 kPa)

Ice Shape



Half Dice
3/8" x 1 1/8" x 7/8"
(.95 x 2.86 x 2.22 cm)



Dice
7/8" x 7/8" x 7/8"
(2.22 x 2.22 x 2.22 cm)



Regular
1 1/8" x 1 1/8" x 7/8"
(2.86 x 2.86 x 2.22 cm)





iT0620 on D420 Storage Bin

- (A) Electrical Entrance (2) Options
- (B) 3/8" (0.95 cm) F.P.T. Water Condenser Inlet (water-cooled units)
- (C) 1/2" (1.27 cm) F.P.T. Water Condenser Outlet (water-cooled units)
- (D) 1/2" (1.27 cm) Auxillary Base Drain Socket
- (E) 3/8" (0.95 cm) F.P.T. Ice Making Water Inlet
- (F) 1/2" (1.27 cm) F.P.T. Ice Making Water Drain
- (G) 3/4" (1.91 cm) Bin Drain

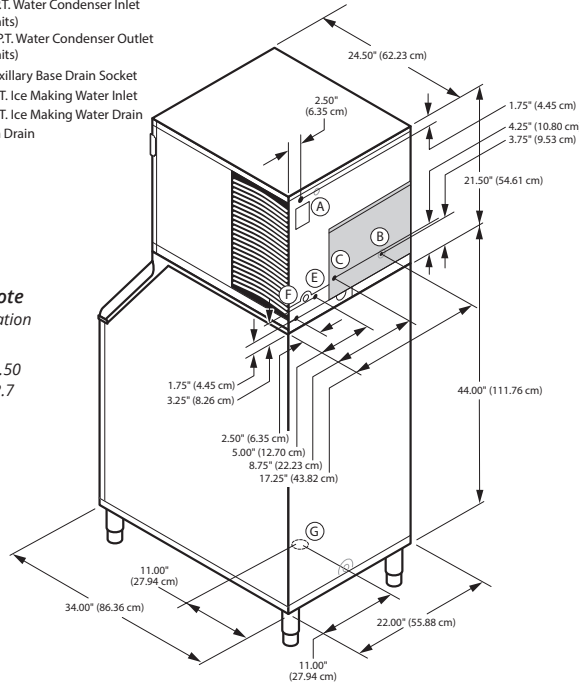

Installation Note
Minimum installation clearance:
Top/side: 12" (30.50 cm)
Back is 5" (12.7 cm)

Space-Saving Design



	iT0620 D-400	iT0620 D-420
Height	59.50" 151.13 cm	71.50" 181.61 cm
Width	30.00" 76.20 cm	22.00" 55.88 cm
Depth	34.00" 86.30 cm	34.00" 86.30 cm
Bin Storage	365 lbs. 166 kgs.	383 lbs. 174 kgs.

Height includes adjustable bin legs 6.00" to 8.00", (15.24 to 20.32 cm) set at 6.00" (15.24 cm).
Bin capacity is based on 90% of the volume x 33 lbs/ft³ average density of ice.
K00443 bin adapter required for D400 bin. Sold separately

Specifications

	Model	Ice Shape	Ice Production 24 Hours		Power Usage kWh/100 lbs. @90°Air/70°F	Potable Water Usage/100 lbs. 45.4 kgs. of Ice
			70°Air/ 50°F Water	90°Air/ 70°F Water		
AIR COOLED	IRT0620A	regular	525 lbs.	410 lbs.	5.29	19.9 Gal.
			238 kgs	186 kgs		75.3 L
	IDT0620A	dice	560 lbs.	450 lbs.	5.18 ★	19.9 Gal.
WATER COOLED	IYT0620A	half-dice	254 kgs	204 kgs	4.87 ★	75.3 L
			575 lbs.	465 lbs.		19.9 Gal.
	IDT0620W	dice	261 kgs	211 kgs	4.13	75.3 L
			530 lbs.	450 lbs.		19.9 Gal.
IYT0620W	half-dice	240 kgs	204 kgs	3.87	75.3 L	
		560 lbs.	485 lbs.		19.9 Gal.	
			254 kgs.	220 kgs		75.3 L

-Water-cooled Condenser Water Usage / 100 lbs. /45.4 kgs. Of Ice: 140 gal/ 530 L.
-Water-cooled models are excluded from ENERGY STAR qualification.

Order separately: Ice storage bin for all units
★ ENERGY STAR[®] 3.0 qualified

Accessories

LuminIce[®] II Viruses and Bacteria Inhibitor
controls viruses and bacteria in the ice machine



External Scoop holder
protect the ice scoop with the NSF approved versatile scoop holder.

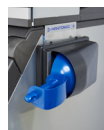

Arctic Pure[®] Water Filters
reduces sediment and chlorine odors for better tasting ice.



iAUCS[®]
schedules and performs routine ice machine cleaning automatically.



Welbilt reserves the right to make changes to the design or specifications without prior notice.