

iT0450 Ice Cube Machine

Models

- IDT0450A IYT0450A IDT0450W IYT0450W



Indigo NXT Series iT0450 Ice Machine on D400 Bin

Designed for operators who know that ice is critical to their business, the Indigo NXT Series ice machine's preventative diagnostics continually monitor itself for reliable ice production. Improvements in cleanability and programmability make your ice machine easy to own and less expensive to operate.

- **New levels of Performance** – Showcasing an average of 9% lower energy consumption, up to 12% increase in ice production and a 19% reduction in condenser water usage and a 5% reduction in potable water usage. . This translates into lower cost of ownership over the life of your machine.
- **easyTouch[®] Display** - New icon based touch screen takes the guess work out of owning and operating an ice machine.
- **Programmable Ice Production** – Now its super easy to program your ice machine to be off at certain times of the day to save money with fluctuating electrical rates. Also programmable by daily ice production volume and night time programming..
- **Easy to Clean Foodzone** – Hinge front door swing out for easy access. Removable water-trough, distribution tube, curtain, water probe and water pump for fast and efficient cleaning. Selected components are made with AlphaSan[®] antimicrobial.
- **Intelligent Diagnostics** – Provides 24 hour preventative maintenance and diagnostic feedback for trouble free operation.
- **Acoustical Ice Sensing Probe** – Unique patented technology allows for reliable operation in challenging water conditions and environments
- **DuraTech[®] Exterior** – Provides superior corrosion resistant above stainless steel. Innovative clear-coat resists fingerprints and dirt making it easier to keep clean.
- Available **LuminIce[®] II Virus and Bacteria Inhibitor** – Controls viruses, bacteria, and yeast within the food zone to keep the ice machine cleaner longer. A new sanitation icon lets you know the operational status.
- **Active Sense**- insures consistent ice harvest in all environmental conditions. This software works in con junction with the acoustical ice sensing probe improving reliability and performance.

Ice Machine Electric

115/60/1 standard
(208-230/60/1 also available)

Minimum circuit ampacity:

Air-cooled: 115v : 11.9, 208-230v : 5.6
Water-cooled: 115v : 11.2, 208-230v : 5.3

Maximum fuse size:

Air Cooled: 20 amps
Water cooled & 208-230 V: 15 amps



Specifications

BTU Per Hour:
3,800 (average),
and 6,000 (peak)

Refrigerant:

R410A CFS - Free
Lowers global warming
by 48%

Operating Limits:

- Ambient Temperature Range:
40 to 110 F (4.4 to 43.3 C)
Water Temperature Range:
40 to 90 F (4.4 to 32.2 C)
- Potable Water Pressure:
Min. 20 psi (137.9 kPa)
Max. 80 psi (551.1 kPa)
- Condenser Water Pressure:
Min. 20 psi (137.9 kPa)
Max. 276 psi (551.1 kPa)

Ice Shape



Half Dice
3/8" x 1 1/8" x 7/8"
(.95 x 2.86 x 2.22 cm)



Dice
7/8" x 7/8" x 7/8"
(2.22 x 2.22 x 2.22 cm)





iT0450 on D-400 Storage Bin

- (A) Electrical Entrance (2) Options
- (B) 3/8" (0.95 cm) F.P.T. Water Condenser Inlet (water-cooled units)
- (C) 1/2" (1.27 cm) F.P.T. Water Condenser Outlet (water-cooled units)
- (D) 1/2" (1.27 cm) Auxillary Base Drain Socket
- (E) 3/8" (0.95 cm) F.P.T. Ice Making Water Inlet
- (F) 1/2" (1.27 cm) F.P.T. Ice Making Water Drain
- (G) 3/4" (1.91 cm) Bin Drain

Installation Note
 Minimum installation clearance:
 Top/side: 8" (30.50 cm)
 Back is 5" (12.7 cm)

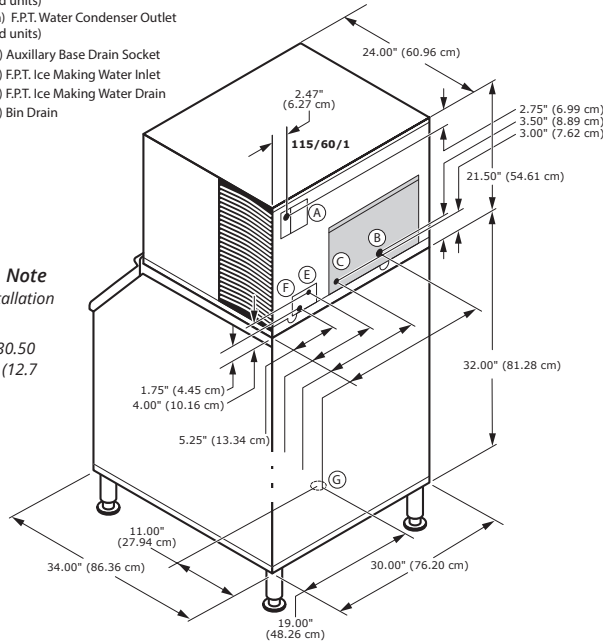

Space-Saving Design



	iT0450 D-400	iT0450 D-570
Height	59.50" 151.13 cm	71.50" 181.61 cm
Width	30.00" 76.2 cm	30.00" 76.2 cm
Depth	34.00" 86.30 cm	34.00" 86.30 cm
Bin	365 lbs.	532 lbs.
Storage	165.7 kgs.	241.1 kgs.

Height includes adjustable bin legs 6.00" to 8.00", (15.24 to 20.32 cm) set at 6.00" (15.24 cm).
 Bin capacity is based on 90% of the volume x 33 lbs/ft³ average density of ice.

Specifications

	Model	Ice Shape	Ice Production 24 Hours		Power Usage kWh/100 lbs. @90°Air/70°F 1 Ph	Potable Water Usage/100 lbs. 45.4 kgs. of Ice
			70°Air/ 50°F Water	90°Air/ 70°F Water		
AIR COOLED	IDT0450A	dice	470 lbs.	358 lbs.	5.63 ★	19 Gal. 71.9 L
			213 kgs	162 kgs		
AIR COOLED	IYT0450A	half-dice	490 lbs.	378 lbs.	5.52 ★	19 Gal. 71.9 L
			222 kgs	171 kgs		
WATER COOLED	IDT0450W	dice	430 lbs.	360 lbs.	4.75	19 Gal. 71.9 L
			195 kgs	163 kgs		
WATER COOLED	IYT0450W	half-dice	470 lbs.	420 lbs.	4.20	19 Gal. 71.9 L
			213 kgs.	191 kgs		

* Water-cooled Condenser Water Usage / 100 lbs. /45.4 kgs. Of Ice: 140 gal/ 530 L.
 *Water-cooled models are excluded from ENERGY STAR qualification.

Order separately: Ice storage bin for all units
 ★ ENERGY STAR[®] 3.0

Accessories

LuminIce[®] II Virus and Bacteria Inhibitor
 controls viruses and bacteria in the ice machine.



External Scoop holder
 protect the ice scoop with the NSF approved versatile scoop holder.



Arctic Pure[®] Water Filters
 reduces sediment and chlorine odors for better tasting ice.



iAuCS[®]
 schedules and performs routine ice machine cleaning automatically.



Welbilt reserves the right to make changes to the design or specifications without prior notice.